



# TECHNICAL GUIDANCE

UW-MINI

UW-2000 Series

ULTRASONIC LEVEL MONITOR

## GENERAL

**UW-2000**, ultrasonic level monitor is a small but high-cost-performance level monitor in use of ultra sound.

It has a compact and clean body made of polypropylene. It is suitable for the level management of pure water and/or chemical substances. 4 to 20 mA DC current output, two alarm output for high and low level detection. UW-2000 enables you simple and easy level monitoring and controlling.

## FEATURES

- Low cost, small, light and compact.
- Simple and clean construction made of polypropylene.
- Suitable for semi-conductor process and food industries which require non-contact level measurement of water, pure water and chemical substances.
- Superb for remote level control by 4 to 20 mA DC output and 2 points alarm output.
- Shows level and parameters by LED display for monitoring and data setting using key-switches.
- Available with CE marking for EMC.

## SPECIFICATION

- Measuring range                    4.0 m Max. (UW-2100)  
    9.99 m Max. (UW-2200)
- Minimum output range            0.2 m
- Blocking distance                 0.25 m            (UW-2100)  
    0.50 m            (UW-2200)
- Ultrasonic frequency             100 kHz         (UW-2100)  
    50 kHz            (UW-2200)
- Beam angle                         7° (Half angle)
- Indication (Inside cover)
  - Level indication                    3-digit LED indication  
    (Character height 8mm, red)
  - Indication unit                     : cm
  - Parameter indication             : change with key - switches
- Measuring accuracy
  - Indication accuracy              ±0.25% of max. measuring range or 1 cm  
    (whichever is the larger)
- Setting (free setting with key - switches inside the body)
  - High and low alarm level
  - Current output level range
  - Number of sampling data
  - Other display units selectable



- Output function
  - Level signal                         4 to 20mA DC / Isolated  
    Max. load resistance : 500 Ω  
    Resolution                 : ±0.1mA
  - High and low alarm output        Open collector NPN  
    Load : 30V DC / 0.1A Max
  - RS232C Output
    - Communication speed            : 9600 bps
    - Contents                             : Temperature, Measured distance,  
    Signal intensity, Error
    - Resolution                         : 1mm
- Supply voltage                     12 to 24V DC (rating)  
    10.2 to 27.6V DC (tolerance)
- Power consumption                : approx. 3W
- Ambient Temperature             : -20 to +60 °C
- Pressure                             : atmosphere
- Storage temperature              : -30 to +80 °C
- Material
  - Body                                 : PP (Polypropylene)
  - Membrane                         : PP (Polypropylene)
  - O-ring                               : Fluorine rubber
- Installation Thread                : G2 thread
- Enclosure                            IP65
- Memory back up                    EEPROM (for set parameters)
- Mass                                 approx. 350g (without cable)
- Cable                                 10 m / Water proof connector type  
    0.3 mm 2 x 8C with screen /

**DIMENSIONS**

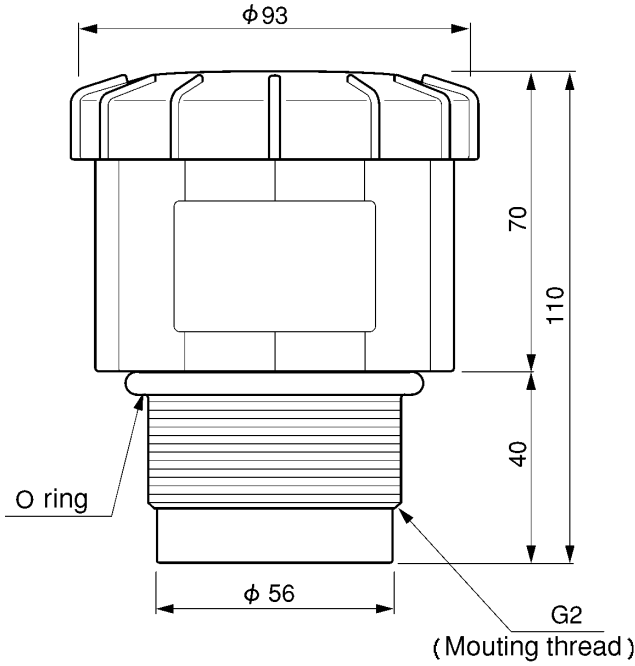

**DISPLAY AND KEYS (interior of the cover)**

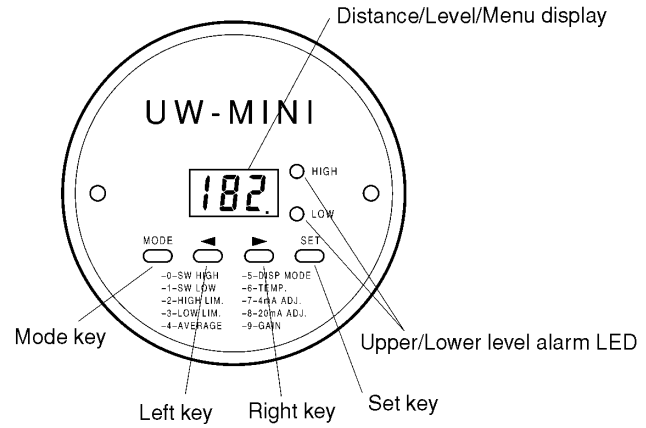

- Operation Menu**
- 0: Setting of upper alarm level
  - 1: Setting of lower alarm level
  - 2: Setting of level for 20mA output
  - 3: Setting of level for 4mA output
  - 4: Setting of numbers of sampling
  - 5: Setting of LED display
  - 6: Display of temperature
  - 7: Adjustment of current output
  - 8: Adjustment of current output
  - 9: Display of signal intensity

**WIRING DIAGRAM**

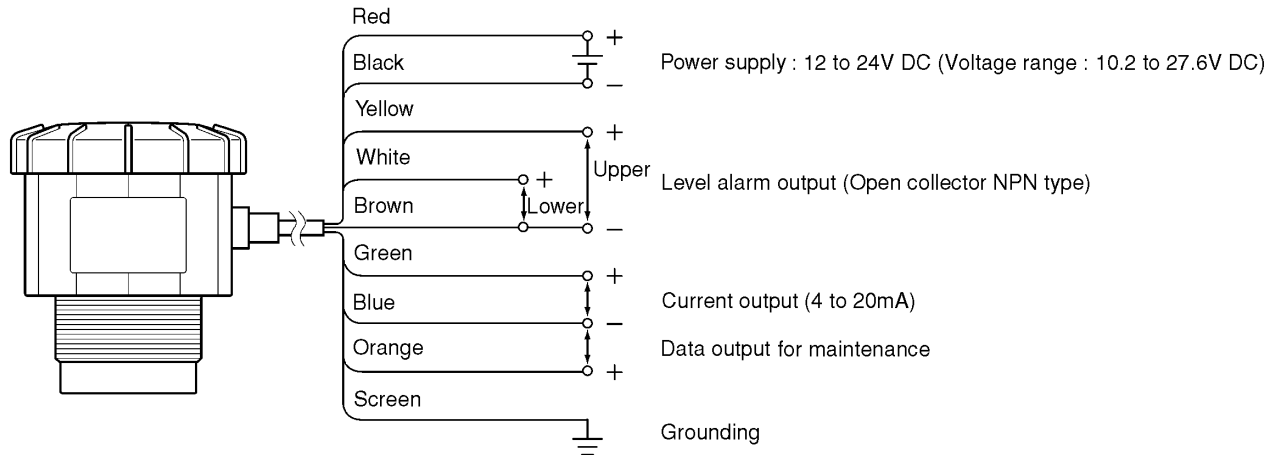

**Caution**

- The maximum contact rating for upper/lower alarm output is 30V DC /0.1A. Use the contact rating shown below.
- Screen should be grounded.
- The blue flying wire and the screen are connected in the instrument.

**MODEL CODE**

Model code	Option code	Note
<b>UW-2</b>	<b>***</b>	<b>/...</b>
Measuring range	<b>100</b>	4m Max.
	<b>200</b>	9.99mMax.
Option	Parameters setting	/RS Setting of specified parameters before shipment If parameters are not specified, the instrument will be shipped with default setting.

Option code should be attached at the end of the model code  
Example: UW-2100/RS

**ORDERING INSTRUCTIONS**

Model code and option code

## MOUNTING RECOMMENDATIONS

Mount the instrument horizontally on top of the vessel.  
Screw in ISO G2 female thread.

● Mounting example

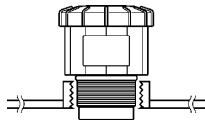

Mounting on threaded socket

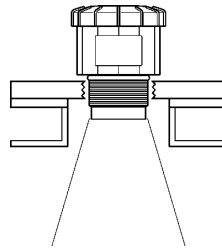

Mounting on threaded flange

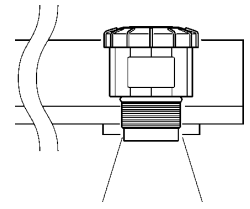

Mounting on beam with threaded hole

### Caution for mounting

- ◆ Screw in by hand. Do not tighten too hard. It may damage the instrument.
- ◆ Do not install plural sensors in one vessel. They may interfere with each other's ultra sound and render measurement impossible.
- ◆ Mount the instrument so that the membrane intrudes into the vessel.
- ◆ When equipping a nozzle, pay attention not to make unevenness inside the nozzle.  
The diameter of the nozzle should be larger than the nozzle length.
- ◆ Attaching a sunshade is recommended if the instrument is likely to be exposed to direct sun light.
- ◆ Select the mounting location where the inner structure such as ladders, temperature sensors and/or inlet stream of the product are outside the range of the sound robe.
- ◆ Ensure that sound robe does not touch the mounting nozzle and/or vessel wall.
- ◆ Insert attached O ring when installing the instrument to ensure the proper emission of the sound. Avoid the installation on the thin plate.

### Sound robe (beam angle)

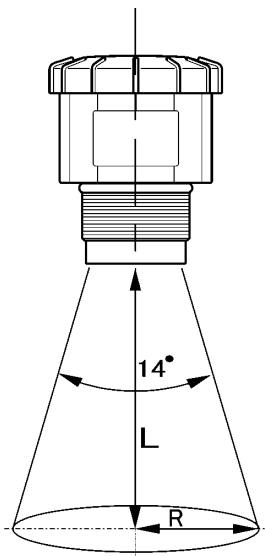

L(m)	R(m)
0.25	0.06
0.50	0.09
1.00	0.15
2.00	0.28
4.00	0.52
5.00	0.64
7.00	0.89
8.00	1.01
10.00	1.26

● Note for installation

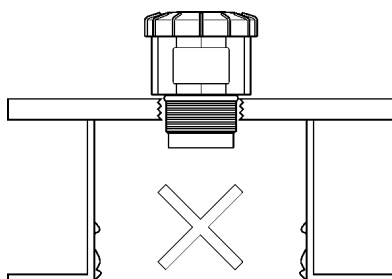

Bumps such as welding bead or burr should not be in the mounting nozzle.

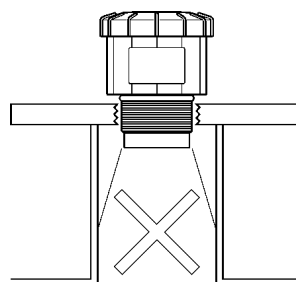

Avoid sound robe touching the nozzle

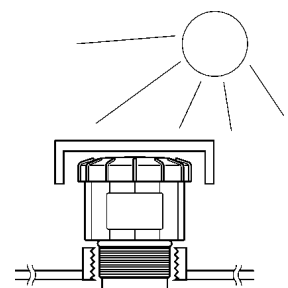

Attach a sunshade in case of direct sun light.

**Mounting location**

- ◆ Mount the instrument parallel to the measured surface where no object causes interference.
- ◆ Mount the instrument at least 200mm apart from the vessel wall. (Noises may cause a faulty functioning.)
- ◆ Avoid mounting the instrument close to the center of the vessel roof. Special care must be taken for conical or dome roof tank. It may create double echo.
- ◆ Strong waves or the foam on the measuring surface or dense vapor or gas makes the measurement impossible.

**Mounting example**

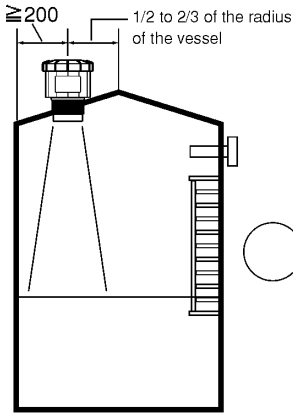

Where there is no likelihood of interference

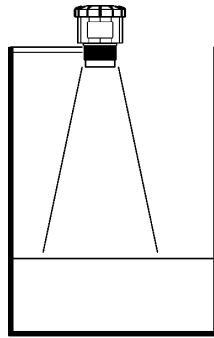

Mount on arm for pit or canal measurement

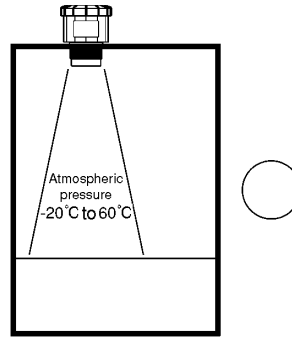

Keep within operating temperature and pressure ranges

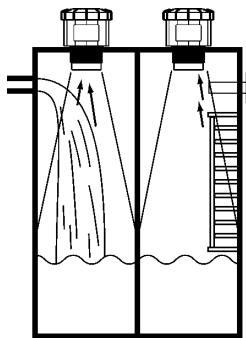

Avoid mounting close to the inlet nozzle and interference

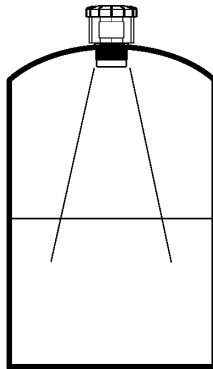

Avoid mounting close to the center of the vessel

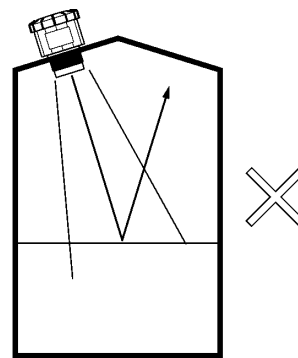

Mount the membrane parallel to the measured surface

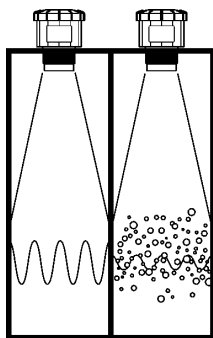

Avoid strong waves and foaming on measured surface

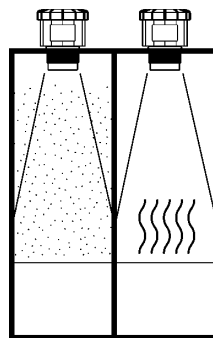

Avoid dense vapor and gas in the vessel

\* Specification is subject to change without notice.

**TIV TOKYO KEISO CO., LTD.**

Head Office : Shiba Toho Building, 1-7-24 Shibakoen, Minato-ku, Tokyo 105-8558  
 Tel : +81-3-3431-1625 (KEY) ; Fax : +81-3-3433-4922  
 e-mail : overseas.sales@tokyokeiso.co.jp ; URL : http://www.tokyokeiso.co.jp

